

Roll-conteneur (1 Réf. 9626_, 3x Réf. 9625_ et 1 Réf. 9635_)



3 Roll-conteneurs pliés

Plié avec roulettes



Gerbables et aussi pliables à vide afin d'optimiser le volume occupé.

Plié sur palette de 1,2x0,8m



Les bacs sans fond sont gerbables de manière à doubler ou à tripler la hauteur interne.

Bac sans fond



Bac sans fond (Réf. 9620_) gerbé sur un bac avec fond (Réf. 9621_)



Ref. 9620_



Bac à roulettes,
déplié et plié

H = 590mm

Ref. 9622_

Bac avec portes latérales
Réf. 9625_ déplié et plié

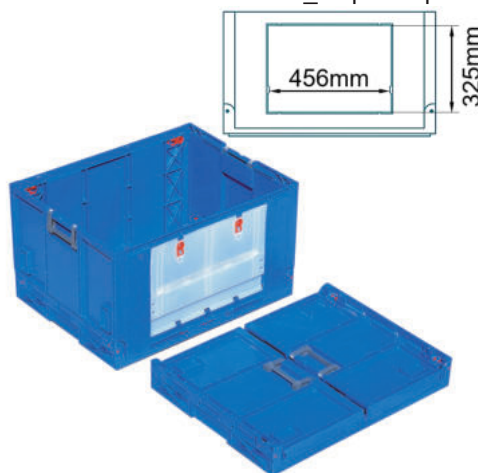

Ref. 9625_

La version avec portes (Réf. 9625_) et la version avec ouverture latérale (Réf. 9628_) permettent l'accès lateral pour le picking.

Le couvercle Réf. 9635_ permet de mettre les bacs sous scellés de sécurité, pour assurer l'inviolabilité.



Bac avec fond Réf. 9621_
gerbé sur bac à roulettes
Réf. 9622_.



2 Bacs à roulettes
Réf. 9622_ et
couvercles Réf. 9635_

Les Bacs sont gerbables les uns sur les autres, avec ou sans couvercles, que ce soit avec ou sans roulettes.

	Réf.	Kg
Sans fond	9620_	6.72
Avec fond	9621_	8.28
Avec fond et roulettes	9622_	10.38
Avec portes	9625_	8.28
Avec portes et roulettes	9626_	10.38
Avec ouverture latérale	9628_	7.68
Avec ouverture latérale et roulettes	9629_	9.78
Sans fond, avec portes	962P_	6.78
Couvercle	9635_	1.80

BACS POUR PICKING

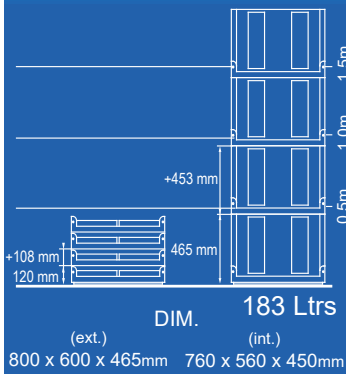

3 bacs avec portes
Ref. 9625_ sur
bac avec portes
et roulettes Ref. 9626_

	Ref.
Avec portes	9625_
Avec portes et roulettes	9626
Avec ouverture latérale	9628
Avec ouverture latérale et roulettes	9629
Couvercle	9635_

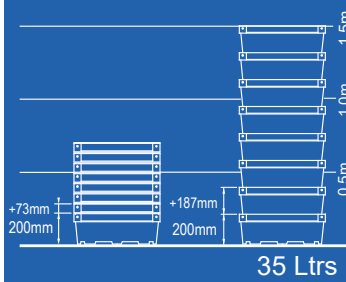

140/
DIM. (ext.) (int.)
600 x 400 x 200mm 530 x 340 x 172mm

Ref. 120P_



130/
DIM. (ext.) (int.)
600 x 400 x 300mm 530 x 340 x 272mm

Ref. 130R_



130/
DIM. (ext.) (int.)
600 x 400 x 300mm 530 x 340 x 272mm

Ref. 130T_

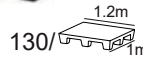
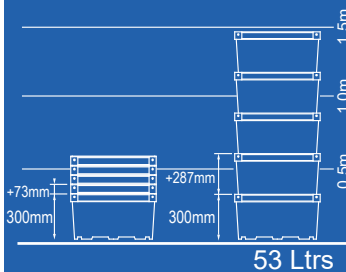

130/
Ref. 130P_

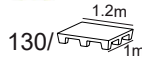
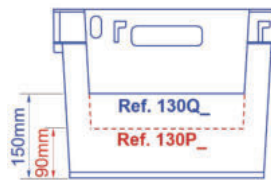

130/
Ref. 130Q_

53 Ltrs

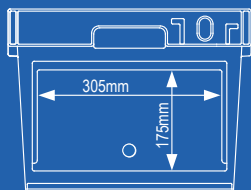

Ref. 1305	Ref. 1306
Avec ouverture	Avec caplet



130/
Ref. 1305_



130/
Ref. 1306_

DIM. (ext.) (int.)
600 x 400 x 300mm 530 x 340 x 272mm

Chariot (600 x 400mm)

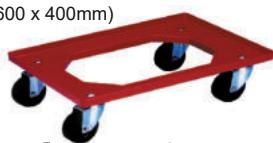

Ref. 9654_

Couvercle (600 x 400mm)



Ref. 3006_

PSAplast
.com

Plásticos Santo António, Lda.
P.O. Box 21, 2416 - 901 Leiria, Portugal
Tel. 00-351-244 81 36 00
Fax. 00-351-244 81 22 21

comercial@psplast.com

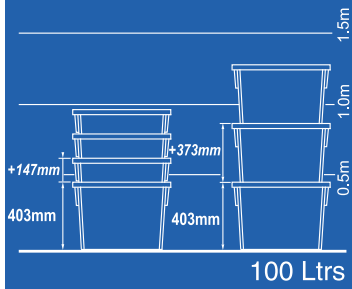

Ref. 3351_

Plein

DIM.
(ext.) 620 x 500 x 403mm (int.) 540 x 430 x 400mm

Emboîtables à vide par rotation de 180° afin d'optimiser l'espace occupé.

Conçus pour la manutention de 4 piles sur palette de 1,2 x 1m.

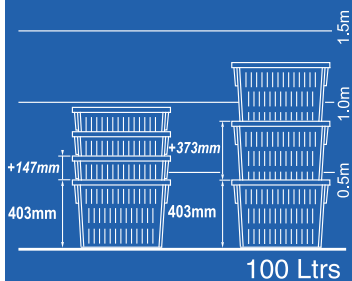

Ref. 3353_

Fond plein et parois ajourées

DIM.
(ext.) 620 x 500 x 403mm (int.) 540 x 430 x 400mm

Chariot



Ref. 9652_

Couvercle (620 x 500 mm)



Ref. 0210_

Série
4000

BACS AVEC COUVERCLES SOLIDAIRES 400x300mm



Ref. 4326_

Plein

DIM. (ext.) 400 x 300 x 265mm (int.) 336 x 254 x 239mm

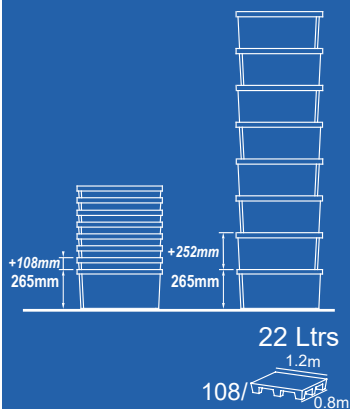

22 Ltrs

108/1.2m
0.8m

Emboîtables à vide afin d'optimiser l'espace occupé.

Gerbables sur les couvercles fermés.

Possibilité de les mettre sous scellés de sécurité pour assurer l'inviolabilité.

Fenêtre porte-étiquette disponible en option.

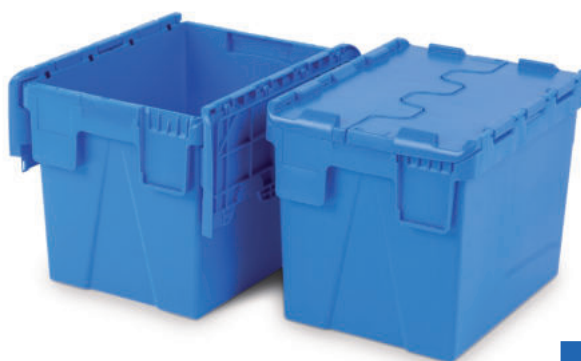

Ref. 4331_

Plein

DIM. (ext.) 400 x 300 x 310mm (int.) 332 x 250 x 282mm

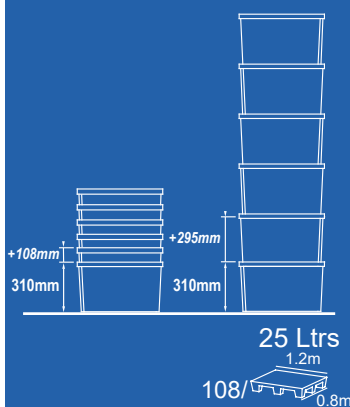

25 Ltrs

108/1.2m
0.8m

Scellé de sécurité



Ref. 6402_



Ref. 6405_

Fenêtre porte-étiquette



Ref. 430J_

Chariot (600 x 400 mm)



Ref. 9654_

PSAplast
.com

Plásticos Santo António, Lda.
P.O. Box 21, 2416 - 901 Leiria, Portugal

Tel. 00-351-244 81 36 00
Fax. 00-351-244 81 22 21

comercial@psaplast.com

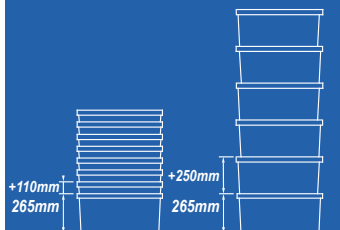

48 Ltrs

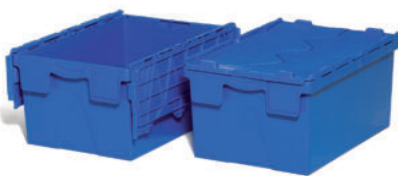

Ref. 6426_

Emboîtables à vide afin d'optimiser l'espace occupé.

Gerbables sur les couvercles fermés.

Possibilité de les mettre sous scellés de sécurité pour assurer l'inviolabilité.

Fenêtre porte-étiquette disponible en option.

Plein

DIM. (ext.) 600 x 400 x 265mm (int.) 530 x 353 x 240mm

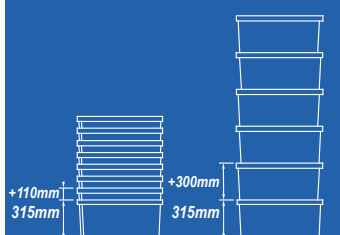

54 Ltrs

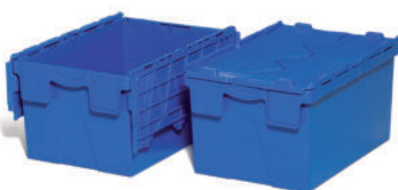

Ref. 6431_

Plein

DIM. (ext.) 600 x 400 x 310mm (int.) 514 x 350 x 281mm

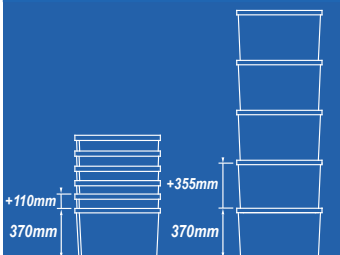

65 Ltrs



Ref. 6436_

Plein

DIM. (ext.) 600 x 400 x 365mm (int.) 508 x 346 x 340mm

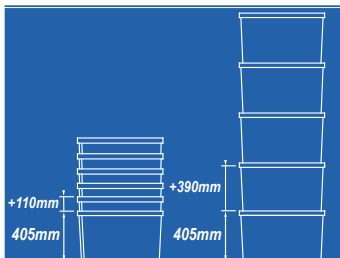

70 Ltrs



Ref. 6440_

Plein

DIM. (ext.) 600 x 400 x 400mm (int.) 521 x 343 x 375mm

Scellé de sécurité



Ref. 6402_



Ref. 6405_

Fenêtre porte-étiquette



Ref. 640J_

Chariot (600 x 400 mm)



Ref. 9654_

PSAplast
.com

Plásticos Santo António, Lda.
P.O. Box 21, 2416 - 901 Leiria, Portugal

Tel. 00-351-244 81 36 00
Fax. 00-351-244 81 22 21

comercial@psaplast.com

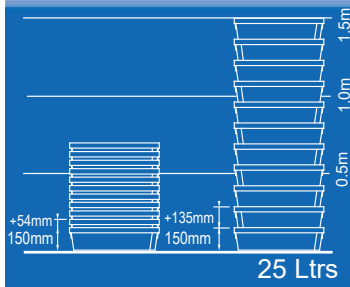

25 Ltrs



195/
ef. 9901_

Le modèle de 25L avec 150mm de hauteur peut être fabriqué sur demande en version ajourée (Ref. 9902_).

Plein

(ext.) DIM. (int.)
600 x 400 x 150mm 490 x 332 x 145mm

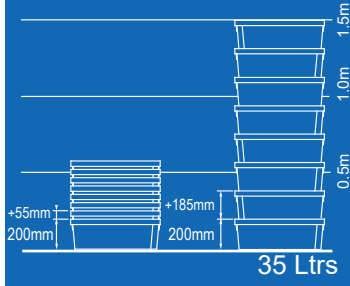

35 Ltrs



190/
Ref. 9701_

Plein

(ext.) DIM. (int.)
600 x 400 x 200mm 490 x 332 x 195mm



190/
Ref. 9702_

Ajouré

(ext.) DIM. (int.)
600 x 400 x 200mm 490 x 332 x 195mm

Emboîtables à vide par rotation de 180°, afin d'optimiser l'espace occupé.

Sur demande tous les modèles peuvent être fabriqués :

- avec parois ajourées et fond plein, ou:
- avec parois pleines et fond ajouré, ou:
- avec roulettes, fond et parois ajourés (Réf. 990R, 970R et 980R):
- avec roulettes, parois pleines et fond ajouré

Le couvercle Ref. 3006_ permet de mettre les bacs sous scellés de sécurité, pour assurer l'inviolabilité.

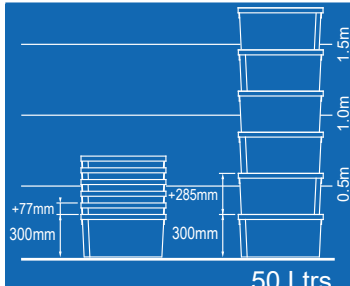

50 Ltrs



130/
Ref. 9751_

Plein

(ext.) DIM. (int.)
600 x 400 x 300mm 490 x 332 x 295mm



130/
Ref. 9752_

Ajouré

(ext.) DIM. (int.)
600 x 400 x 300mm 490 x 332 x 295mm

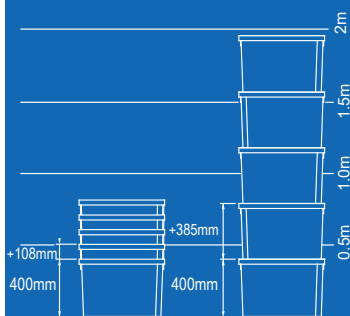

70 Ltrs



90/
Ref. 9801_

Plein

(ext.) DIM. (int.)
600 x 400 x 400mm 490 x 332 x 395mm



90/
Ref. 9802_

Ajouré

(ext.) DIM. (int.)
600 x 400 x 400mm 490 x 332 x 395mm



90/
Ref. 980R_

Avec roulettes

Chariot (600x400mm)

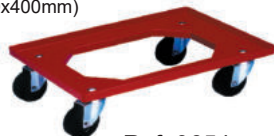

Ref. 9654_

Couvercle (600x400mm)



Ref. 9656_



Ref. 3006_

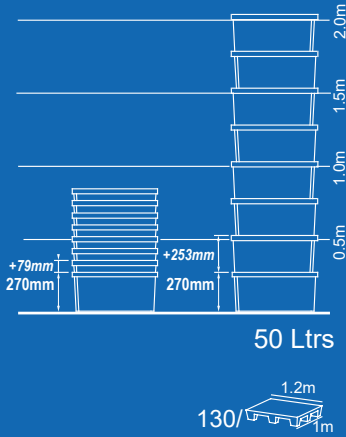

50 Ltrs

130/ 1.2m
1m



Ref. 2271_

Plein



Ref. 2272_

Ajouré

DIM. (ext.)600 x 400 x 270mm (int.)490 x 340 x 267mm

Gerbables et emboîtables à vide par une rotation de 180°, afin d'optimiser l'espace occupé.

Les bacs de la Série 2000 offrent plus de volume intérieur par rapport d'autres bacs gerbables/emboîtables, grâce à des parois moins profilées.

Sans ouvertures sous les poignées. Le couvercle Réf. 3006_ permet de mettre les bacs sous scellés de sécurité, pour assurer l'inviolabilité.

Sur demande de bac de 270mm de hauteur peut être fabriqué avec fond plein et parois ajourées (Réf. 2273_).

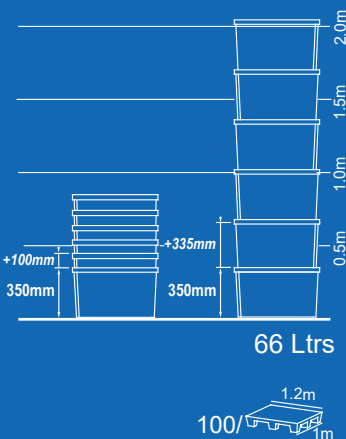

66 Ltrs

100/ 1.2m
1m



Ref. 2351_

Plein



Ref. 2353_

Fond plein et parois ajourées



Ref. 2352_

Ajouré

DIM. (ext.)600 x 400 x 350mm (int.)490 x 340 x 347mm

Chariot (600 x 400 mm)



Ref. 9654_



Ref. 9656_

Couvercle (600 x 400 mm)

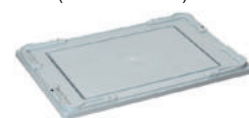

Ref. 3006_

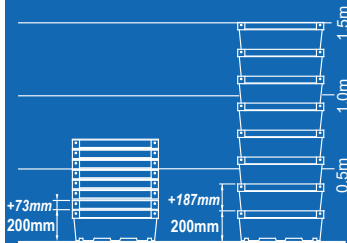

35 Ltrs

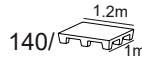

140/

Ref. 1201_

Plein



140/

Ref. 1202_

Ajouré

DIM.

(ext.) 600 x 400 x 200mm (int.) 530 x 340 x 172mm

Emboîtables à vide afin d'optimiser le volume occupé.

Le système de gerbage sur rabats permet au bac d'offrir des parois internes planes, pour maximiser le volume intérieur.

Porte-étiquette inclus.

Sur demande tous les modèles peuvent être fabriqués avec parois ajourées et fond plein ou vice-versa.

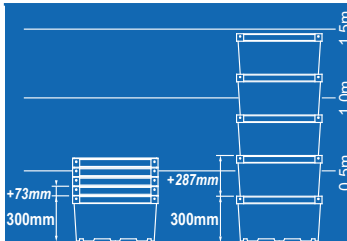

53 Ltrs



130/

Ref. 1301_

Plein



130/

Ref. 1305 /1306_



130/

Ref. 1302_

Ajouré

DIM.

(ext.) 600 x 400 x 300mm (int.) 530 x 340 x 272mm

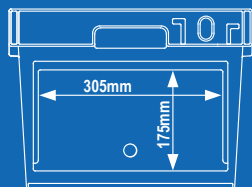

Ref. 1305	Ref. 1306
Avec ouverture	Avec clapet

Chariot (600 x 400 mm)

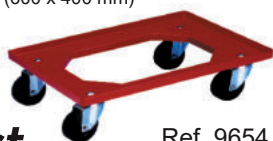

Ref. 9654_

Couvercle (600 x 400 mm)

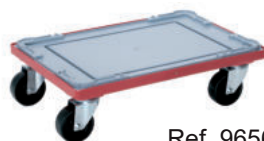

Ref. 9656_



Ref. 3006_

PSAplast
.com

Plásticos Santo António, Lda.
P.O. Box 21, 2416 - 901 Leiria, Portugal

Tel. 00-351-244 81 36 00
Fax. 00-351-244 81 22 21

comercial@psaplast.com

Bacs ajourés



Ref. 9610_

Ref. 9611_

Ref. 9612_

DIM. (ext.) 600 x 400 x 59mm
(int.) 580 x 380 x 57mm

DIM. (ext.) 600 x 400 x 77mm
(int.) 580 x 380 x 75mm

DIM. (ext.) 600 x 400 x 92mm
(int.) 580 x 380 x 90mm

Bacs pleins



Ref. 9613_

Ref. 9614_

Ref. 9615_

DIM. (ext.) 600 x 400 x 59mm
(int.) 580 x 380 x 57mm

DIM. (ext.) 600 x 400 x 77mm
(int.) 580 x 380 x 75mm

DIM. (ext.) 600 x 400 x 92mm
(int.) 580 x 380 x 90mm

Versions

Sans réhausses	Petites réhausses	Grandes réhausses
----------------	-------------------	-------------------



Hauteur (mm)

59

77

92

Conçus pour le transport et le stockage de différents produits (pain, pâtisseries, fromages, viandes, fruits, légumes, etc...)

Les versions 9612_, 9615_, 9616_ et 9617_ sont des modèles standard et immédiatement disponibles. Les autres versions sont fabriquées sur demande.



Fond plein et parois ajourées



Ref. 9616_

Ref. 9617_

Ref. 9618_

DIM. (ext.) 600 x 400 x 59mm
(int.) 580 x 380 x 57mm

DIM. (ext.) 600 x 400 x 77mm
(int.) 580 x 380 x 75mm

DIM. (ext.) 600 x 400 x 92mm
(int.) 580 x 380 x 90mm

Fond ajouré et parois pleines



Ref. 9631_

Ref. 9632_

Ref. 9633_

DIM. (ext.) 600 x 400 x 59mm
(int.) 580 x 380 x 57mm

DIM. (ext.) 600 x 400 x 77mm
(int.) 580 x 380 x 75mm

DIM. (ext.) 600 x 400 x 92mm
(int.) 580 x 380 x 90mm

Sur demande, personnalisation du bac avec le nom de la société, l'adresse ou le logo.

Chariot (600 x 400 mm)



Ref. 9654_

Couvercle (600 x 400 mm)



Ref. 3006_



BACS GERBABLES

Conçus pour les industries fromagères et pâtisseries, ces bacs sont aussi utilisés à d'autres fins qui exigent des dimensions internes différentes de celles des bacs 600x400mm ou 400x300mm.

Le couvercle Ref. 7860_ est approprié pour les Réf. 7870_ ou 7871_ et rend possible le gerbage stable pour une pile de bacs Réf. 9280_ ou 2 piles de bacs Réf. 9015_.

Réf.	DIM. (ext.)	DIM. (int.)
7870_	680x450x120mm	615x410x110mm
7871_	680x450x152mm	615x410x142mm
9015_	435x300x95mm	400x275x75mm
9280_	500x320x105mm	460x300x85mm
7860_	Couvercle	



Conçus avec un système de drainage pour l'industrie du poisson, ces bacs sont aussi utilisés à d'autres fins qui exigent des dimensions internes différentes de celles des bacs 600x400mm.

Permet le gerbage aligné ou décalé.



Bac à poisson



Réf. 9500_ DIM. (ext.) 725 x 485 x 130mm (int.) 680 x 475 x 118mm

Bac gerbable ajouré



Réf. 332_

DIM. (ext.) 500 x 310 x 255mm (int.) 470 x 280 x 245mm

Bac gerbable plein



Réf. 8470_

DIM. (ext.) 400 x 300 x 170mm (int.) 385 x 280 x 160mm

Chariot (600 x 400 / 680 x 450 mm)



Réf. 9654_

Couvercle (680 x 450 mm)

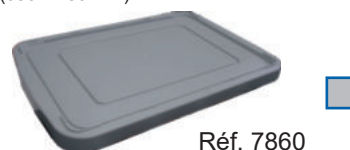

Réf. 7860_

PSAplast
.com

Plásticos Santo António, Lda.
P.O. Box 21, 2416 - 901 Leiria, Portugal

Tel. 00-351-244 81 36 00
Fax. 00-351-244 81 22 21

comercial@psaplast.com

BAC EN PLASTIQUE EMBOÎTABLE

Bac emboîtable



Ref. 9450_

DIM.
540mm x 380mm x 80mm

Bac utilisé dans les aéroports pour le contrôle des bagages à main.



PSAplast
.com

Plásticos Santo António, Lda.
P.O. Box 21, 2416 - 901 Leiria, Portugal
Tel. 00-351-244 81 36 00
Fax. 00-351-244 81 22 21

comercial@psaplast.com

BACS EN PLASTIQUE AVEC OU SANS GRILLES

Bac disponible avec ou sans grilles.

Bac sans grilles



Ref. 9450

DIM.
540 x 380 x 80mm

Bac avec 2 grilles



Ref. 9451

DIM.
540 x 380 x 80mm



Bac gerbable/emboîtable avec 2 grilles et couvercle



Ref. 9452

Grille (295x230x13mm)

Bac gerbable/emboîtable + 2 grilles Ref. 9452_



Ref. 3006

Couvercle (600x400mm)

Ref. 9901

DIM.
600 x 400 x 150mm

PSAplast
.com

Plásticos Santo António, Lda.
P.O. Box 21, 2416 - 901 Leiria, Portugal

Tel. 00-351-244 81 36 00
Fax. 00-351-244 81 22 21

comercial@psaplast.com

BACS À VENDANGE

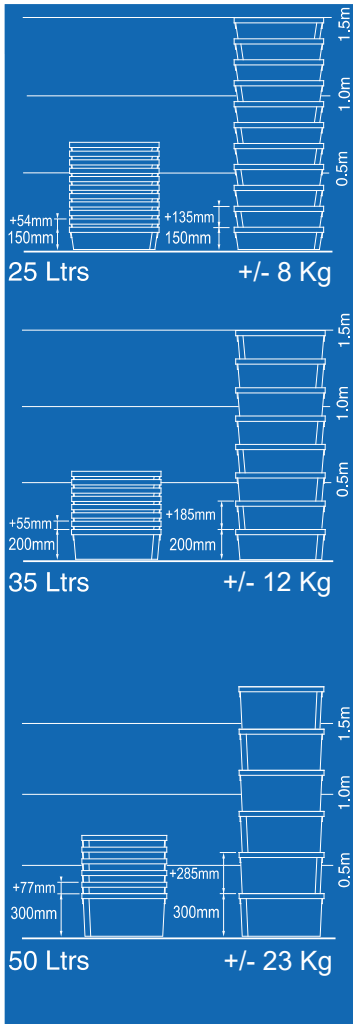
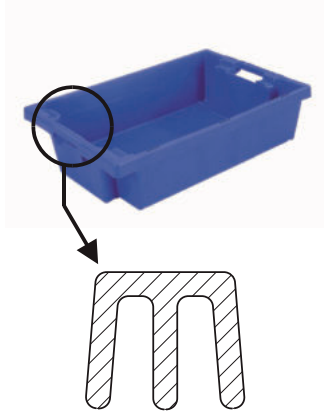

Plein

DIM.

600 x 400 x 150mm 195/1m

Ref. 9901_

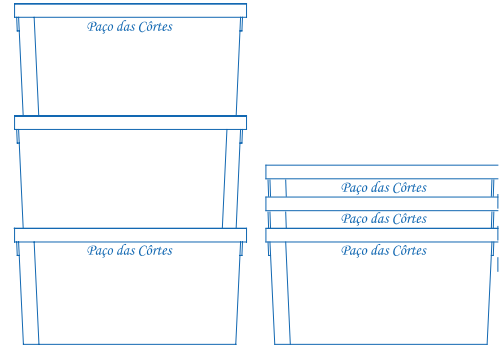

Plein

DIM.

600 x 400 x 200mm 190/1m

Ref. 9701_

Le marquage sur un côté assure une distinction immédiate des positions pour le gerbage ou l'emboîtement:

- En position de gerbage, le marquage des bacs est alterné.
- En position d'emboîtement, les marquages sont visibles du même côté.

Aussi disponible :

- En 400mm de hauteur (70L)
- En versions ajourées.



Plein

DIM.

600 x 400 x 300mm 130/1m

Ref. 9751_

Sur demande tous les modèles peuvent être fabriqués avec parois ajourées et fond plein.

Les poids indiqués sont approximatifs (la quantité exacte dépendra de la taille et la forme des grappes de raisin).

Chariot (600x400mm)

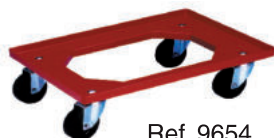

Ref. 9654_

Couvercle (600x400mm)

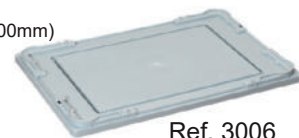

Ref. 3006_

PSAplast.com

Plásticos Santo António, Lda.
P.O. Box 21, 2416 - 901 Leiria, Portugal

Tel. 00-351-244 81 36 00
Fax. 00-351-244 81 22 21

comercial@psaplast.com

CAISSES-PALETTES - (PALOX PLASTIQUE)

Ref. P749L_

Couvercle de 1,2x1m



Pleine

DIM ext. (mm) 1200 x 1000 x 1200
DIM int. (mm) 1127 x 927 x 1044 1120 Ltrs

Ref.	Semelles
P742T0N_	2
P742E0N_	2-R
P742U0N_	3
P742F0N_	3-R



Ajourée

Ref.	Semelles
P741T0N_	2
P741E0N_	2-R
P741U0N_	3
P741F0N_	3-R

R = Semelles démontables
(version plus résistante)



Pleine

DIM ext. (mm) 1200 x 1000 x 900
DIM int. (mm) 1121 x 921 x 744 800 Ltrs

Ref.	Semelles
P744T0N_	2
P744E0N_	2-R
P744U0N_	3
P744F0N_	3-R



Ajourée

Ref.	Semelles
P743T0N_	2
P743E0N_	2-R
P743U0N_	3
P743F0N_	3-R

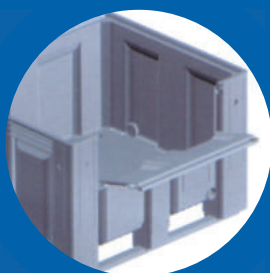

Ref. P746T0D_

Pleine, avec 2 semelles et porte latérale



Pleine

DIM ext. (mm) 1200 x 1000 x 760
DIM int. (mm) 1119 x 919 x 604 650 Ltrs

Ref.	Semelles
P746T0N_	2
P746E0N_	2-R
P746U0N_	3
P746F0N_	3-R



Ajourée

Ref.	Semelles
P745T0N_	2
P745E0N_	2-R
P745U0N_	3
P745F0N_	3-R

PSAplast
.com

Plásticos Santo António, Lda.
P.O. Box 21, 2416 - 901 Leiria, Portugal

Tel. 00-351-244 81 36 00
Fax. 00-351-244 81 22 21

comercial@psaplast.com

PALETES ET CAILLEBOTIS

Conforme au contact alimentaire d'après la réglementation européenne.

Modèle avec 9 pieds (sans semelles) qui ne convient pas pour utilisation en rayonnage.

Ces palettes avec 9 pieds s'emboîtent pour réduire le volume occupé (la première occupe une hauteur de 150mm et chaque palette gerbée rajoute une hauteur de 45mm).



CHARGE	
STATIQUE	DINAMIQUE
1000 Kg	800 Kg



Ref. 2281_

Palette



6,9 Kg

DIM.

1200 x 800 x 150mm

Conforme pour contact alimentaire.

Avec 2 semelles.

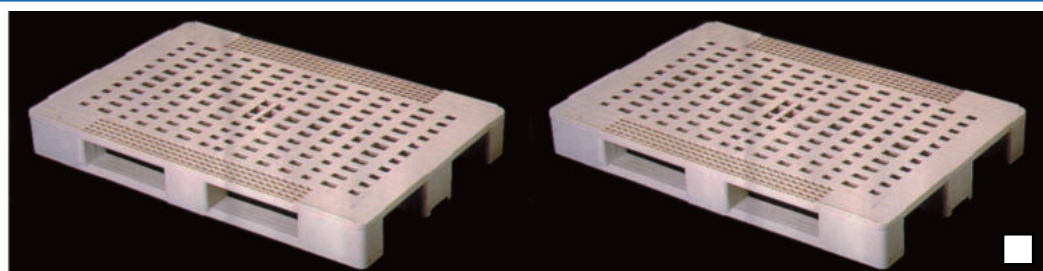

CHARGE		
STATIQUE	DINAMIQUE	RAYONNAGE
1500 Kg	1000 Kg	400 Kg

Ref. 9662_

Palette



14,4 Kg

DIM.

1200 x 800 x 145mm

Caillebotis conforme pour contact alimentaire.

Deux modèles disponibles.

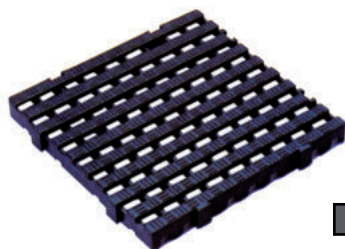

Ref. 9660_

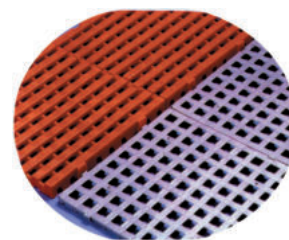

Ref. 9661_

Caillebotis

DIM.

500 x 500 x 48mm

DIM.

500 x 500 x 24mm

PSAplast
.com

Plásticos Santo António, Lda.
P.O. Box 21, 2416 - 901 Leiria, Portugal

Tel. 00-351-244 81 36 00
Fax. 00-351-244 81 22 21

comercial@psaplast.com

Volume

80L POUBELLES À DÉCHETS



Ref. 7900_

Poubelle sans couvercle



Ref. 7901_

Poubelle avec couvercle

DIM.
Ø 480 mm x 670 mm
80 L



Ref. 7902_

Couvercle (à poignée)

PSAplast
.com

Plásticos Santo António, Lda.
P.O. Box 21, 2416 - 901 Leiria, Portugal

Tel. 00-351-244 81 36 00
Fax. 00-351-244 81 22 21

comercial@psaplast.com

POUBELLES ET CORBEILLES (À TRI SÉLECTIF)

Panier à couvercle plat



Ref. 9570_

60 L

DIM.

585 x 435 x 360mm

Poubelle à pédale



Ref. 9580_

60 L

DIM.

730 x 430 x 400mm

Poubelle à couvercle



Ref. 9590_

60 L

DIM.

680 x 430 x 345mm

Corbeille sans couvercle



8 L

295 x 195 x 195mm

Ref. 8900_



6,2 L

217 x 160 x 290mm

Ref. 0230_



13,5 L

217 x 255 x 290mm

Ref. 0240_

Poubelle sans couvercle



Ref. 7880_

60L

DIM.

560 x 425 x 340mm

Poubelles à couvercle basculant



Ref. 9224_

40L

DIM.

690 x 420(Ø380)mm



Ref. 8901_

8L

DIM.

390 x 200 x 200mm

PSAplast
.com

Plásticos Santo António, Lda.
P.O. Box 21, 2416 - 901 Leiria, Portugal

Tel. 00-351-244 81 36 00
Fax. 00-351-244 81 22 21

comercial@psaplast.com

Seau avec couvercle inviolable

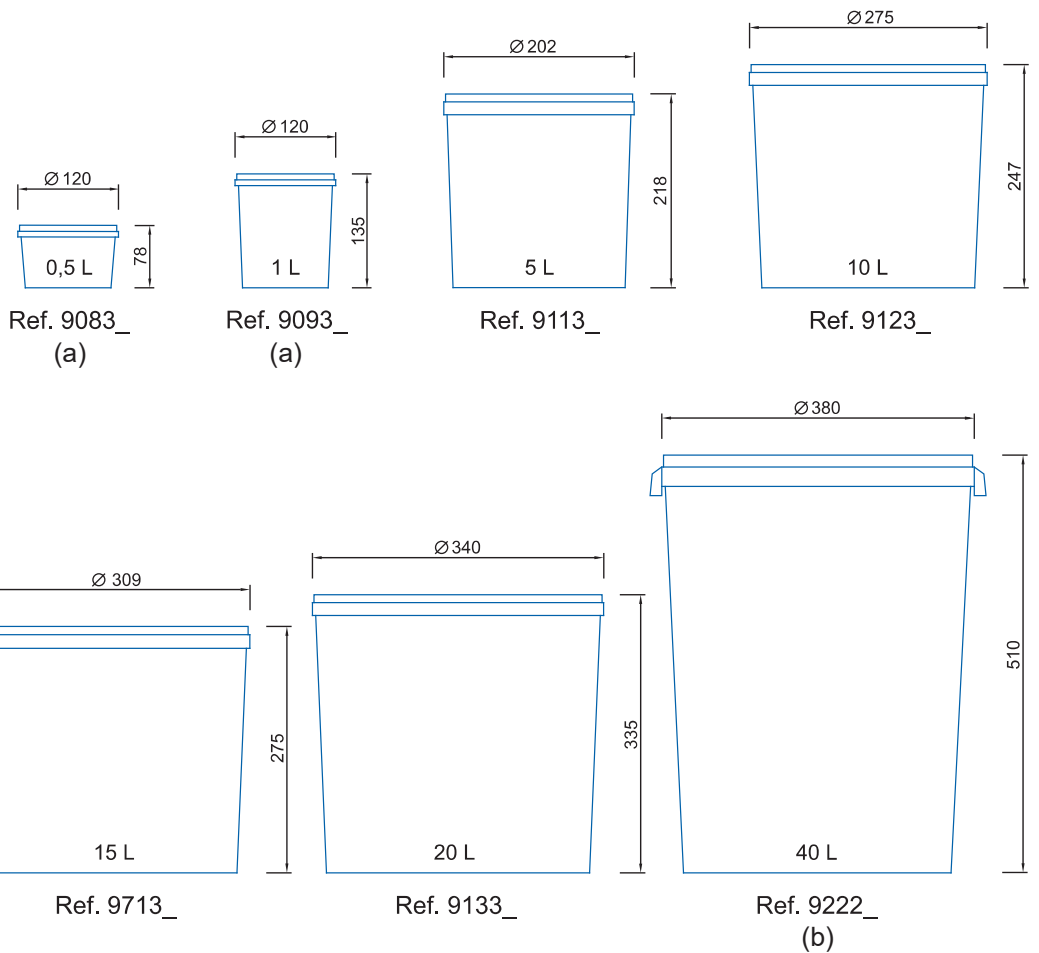

a) sans anse
b) avec 2 poignées

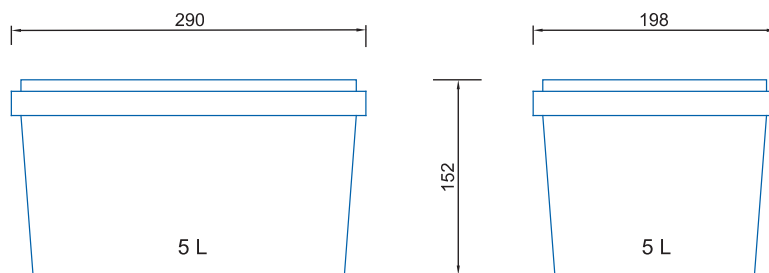

Ref. 9561_

Seau rectangulaire

POTS INVOLABLES AVEC COUVERCLE À PRESSION

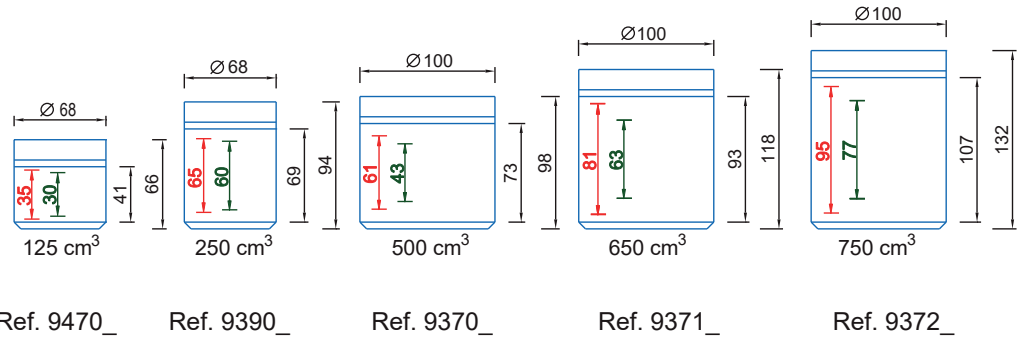

Le couvercle se pose en toute simplicité, par simple pression.

Inviolabilité assurée para une languette qu'il faut retirer pour ouvrir le pot.

Les pots sont fabriqués en polyéthylène Haute Densité et les couvercles en polyéthylène Basse Densité, conformes au contact alimentaire d'après la réglementation européenne.

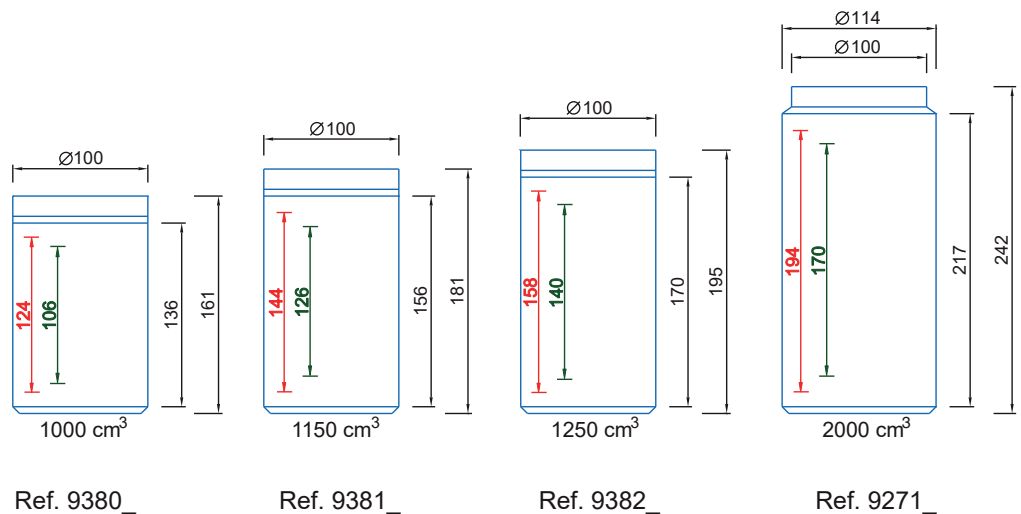

Hauteur maximale d'étiquette (mm)
 Hauteur maximale d'impression (mm)

PSAplast
.com

Plásticos Santo António, Lda.
P.O. Box 21, 2416 - 901 Leiria, Portugal

Tel. 00-351-244 81 36 00
Fax. 00-351-244 81 22 21

comercial@psaplast.com