

Roll-container (1 Ref. 9626_, 3x Ref. 9625_ and 1 Ref. 9635_)



3 Folded roll-containers

Folded with castor wheels

Folded on 1.2x0.8m pallet

Stackable and foldable when empty to minimize the volume.



Boxes with open base can be stacked on other boxes to increase the internal height.

Box with open base



Box with open base stacked on box with solid base.



Ref. 9620_

Does not include the handles shown in the pictures (each handle is sold separately under Ref. 9636_).



Ref. 9636_



Box with castor wheels, assembled or folded.

H = 590mm

Ref. 9622_

Box with drop-doors for side access

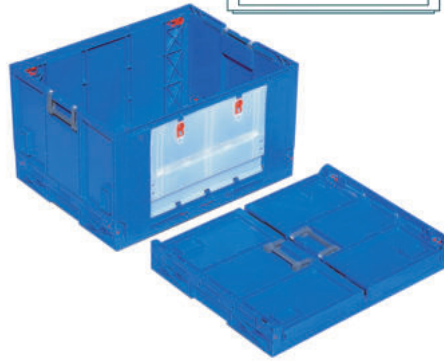
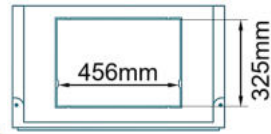

Ref. 9625_

The box with drop-doors Ref. 9625_ enables side access.

The box is also available with side aperture (without doors) Ref. 9628_.

The Lid Ref. 9635_ is designed to enable the use of security seals, for tamper evidence.

Box with solid base Ref. 9621_ stacked on a box with wheels.



2 boxes with wheels Ref. 9622_ and Lids Ref. 9635_.



The boxes can be stacked on each other or over the lids, with or without castor wheels.

	Ref.	Kg
With open base	9620_	6.72
With solid base	9621_	8.28
With castor wheels	9622_	10.38
With drop doors	9625_	8.28
With doors & wheels	9626_	10.38
With side aperture	9628_	7.68
With side aperture & wheels	9629_	9.78
With doors & open base	962P_	6.78
Lid	9635_	1.80

PICKING BOXES

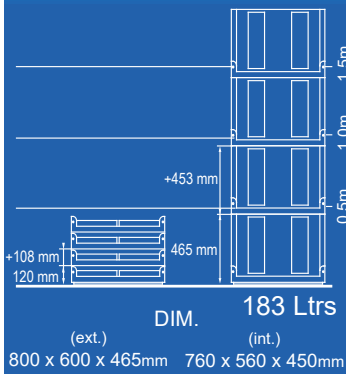

3 boxes with drop doors
Ref. 9625_ stacked on
box with drop doors and
castor wheels Ref. 9626_

	Ref.
With drop doors	9625_
With doors & castor wheels	9626_
With side aperture	9628_
With side aperture & wheels	9629_
Lid	9635_

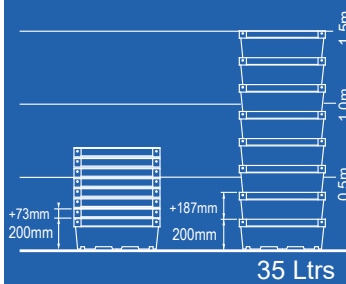

DIM. (ext.) 600 x 400 x 200mm (int.) 530 x 340 x 172mm

Ref. 120P_

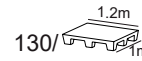

DIM. (ext.) 600 x 400 x 300mm (int.) 530 x 340 x 272mm

Ref. 130R_

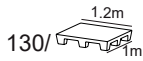

DIM. (ext.) 600 x 400 x 300mm (int.) 530 x 340 x 272mm

Ref. 130T_

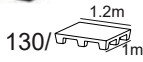
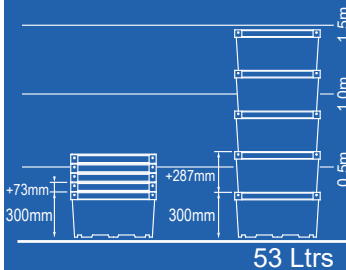

Ref. 130P_

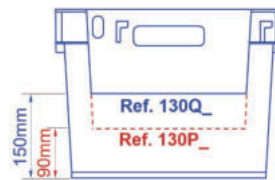

Ref. 130Q_

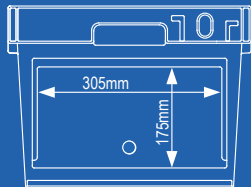

Ref. 1305_	Ref. 1306_
With aperture	With flap-door



Ref. 1305_



Ref. 1306_

DIM. (ext.) 600 x 400 x 300mm (int.) 530 x 340 x 272mm

Dolly (600 x 400mm)



Ref. 9654_

Lid (600 x 400mm)



Ref. 9656_



Ref. 3006_

PSAplast
.com

Plásticos Santo António, Lda.
P.O. Box 21, 2416 - 901 Leiria, Portugal

Tel. 00-351-244 81 36 00
Fax. 00-351-244 81 22 21

comercial@psplast.com

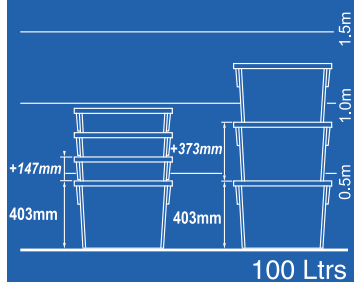

Ref. 3351 _

Solid

DIM.
(ext.) 620 x 500 x 403mm (int.) 540 x 430 x 400mm

Nest when empty. Designed to enable loading of 4 piles on 1,2x1,0m pallets.

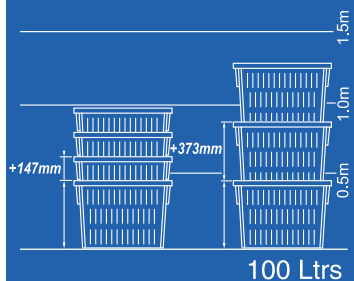

Ref. 3353 _

Solid base & perforated walls

DIM.
(ext.) 620 x 500 x 403mm (int.) 540 x 430 x 400mm

Dolly



Lid (620 x 500 mm)



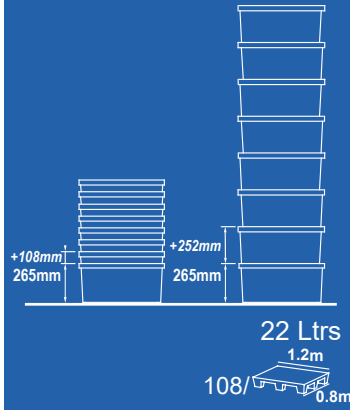

Ref. 4326_

Solid DIM. (ext.) 400 x 300 x 265mm (int.) 336 x 254 x 239mm

- Nest when empty.
- Stack on the closed lids.
- Enable the use of security seals, for tamper evidence.
- Optional ticket-window available.

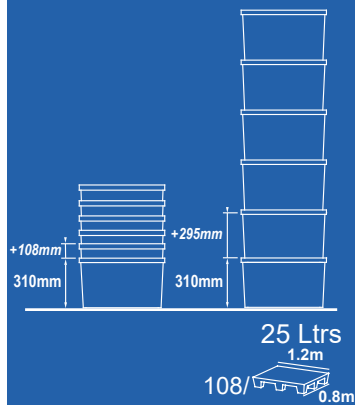

Ref. 4331_

Solid DIM. (ext.) 400 x 300 x 310mm (int.) 332 x 250 x 282mm

Tamper evident seal



Ref. 6402_



Ref. 6405_

Label window



Ref. 430J_

Dolly (600 x 400 mm)



Ref. 9654_

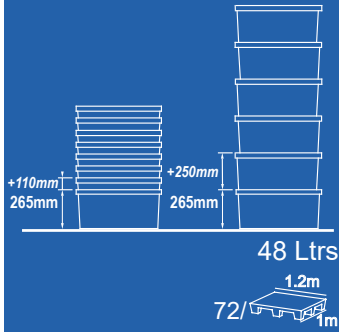

Ref. 6426_

Nest when empty.

Stack on the closed lids.

Enable the use of security seals, for tamper evidence.

Optional ticket-window available.

Solid

DIM.

(ext.) 600 x 400 x 265mm

(int.) 530 x 353 x 240mm

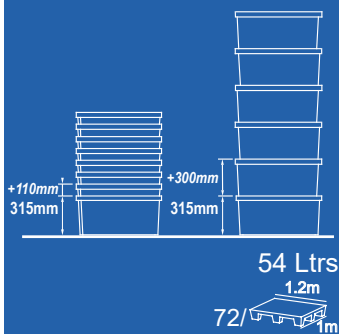

Ref. 6431_

Solid

DIM.

(ext.) 600 x 400 x 310mm

(int.) 514 x 350 x 281mm

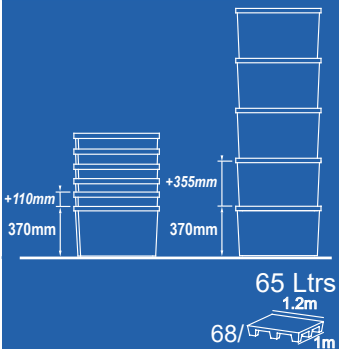

Ref. 6436_

Solid

DIM.

(ext.) 600 x 400 x 365mm

(int.) 508 x 346 x 340mm

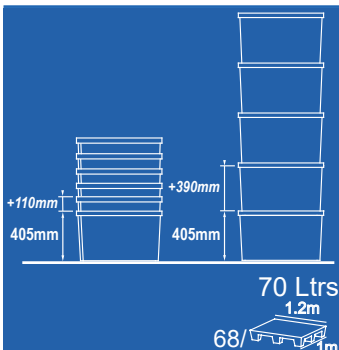

Ref. 6440_

Solid

DIM.

(ext.) 600 x 400 x 400mm

(int.) 521 x 343 x 375mm

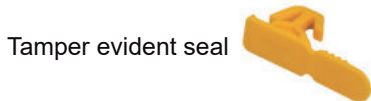

Tamper evident seal

Ref. 6402_



Ref. 6405_

Label window



Ref. 640J_

Dolly (600 x 400 mm)

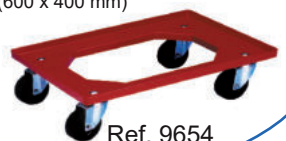

Ref. 9654_

25 Ltrs

	195/	Ref. 9901_	<p>On request, the 25L 150mm high model may be produced with perforated walls and base (Ref. 9902_).</p>
Solid	(ext.) DIM. (int.) 600 x 400 x 150mm 490 x 332 x 145mm		

	190/	Ref. 9701_	
Solid	(ext.) DIM. (int.) 600 x 400 x 200mm 490 x 332 x 195mm		

	190/	Ref. 9702_	
Perforated	(ext.) DIM. (int.) 600 x 400 x 200mm 490 x 332 x 195mm		

Nest when empty.

The lid Ref. 3006_ enables the use of security seals, for tamper evidence.

On request, all models may be produced:

- with perforated walls and solid base, or:
- with solid walls and perforated base, or:
- with wheels, perforated walls and base (Ref. 990R, 970R, and 980R):
- with wheels, solid walls and perforated base.

50 Ltrs

	130/	Ref. 9751_		130/	Ref. 9752_
Solid	(ext.) DIM. (int.) 600 x 400 x 300mm 490 x 332 x 295mm		Perforated	(ext.) DIM. (int.) 600 x 400 x 300mm 490 x 332 x 295mm	

	90/	Ref. 9801_		90/	Ref. 9802_		90/	Ref. 980R
Solid	(ext.) DIM. (int.) 600 x 400 x 400mm 490 x 332 x 395mm		Perforated	(ext.) DIM. (int.) 600 x 400 x 400mm 490 x 332 x 395mm		With wheels		

Dolly (600 x 400 mm)



Ref. 9654_



Ref. 9656_

Lid (600 x 400 mm)



Ref. 3006_

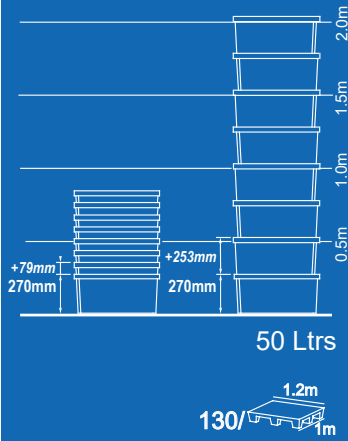

Ref. 2271_

Solid



Ref. 2272_

Perforated

DIM. (ext.) 600 x 400 x 270 mm (int.) 490 x 340 x 267mm

Stack, and also nest when empty to minimize the volume.

These 2000 Series boxes offer an increased internal volume when compared with other 180° turn stack & nesting boxes.

When fitting a lid with security seals, tamper evidence is ensured because these boxes do not have apertures below the handles.

On request all models may be produced with solid base and perforated walls, or with solid walls and perforated base.

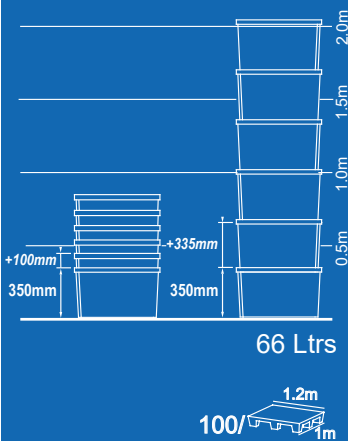

Ref. 2351_

Solid



Ref. 2353_

Solid base & perforated walls



Ref. 2352_

Perforated

DIM. (ext.) 600 x 400 x 350mm (int.) 490 x 340 x 347mm

Dolly (600 x 400 mm)

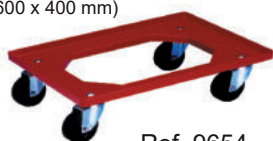

Ref. 9654_

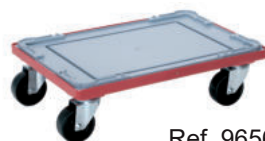

Ref. 9656_

Lid (600 x 400 mm)



Ref. 3006_

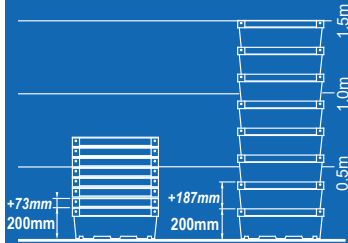

35 Ltrs



Ref. 1201_



Ref. 1202_

Solid

DIM.

Perforated

(ext.) 600 x 400 x 200mm (int.) 530 x 340 x 172mm

Stack, and also nest when empty to minimize the volume.

The bale-arm stacking design contributes to maximize the internal volume.

Includes label holders on the 2 short ends.

All models may be produced with perforated walls and solid base, or vice-versa.

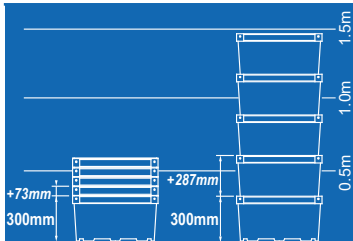

53 Ltrs



Ref. 1301_

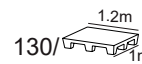

Ref. 1305_ /1306_



Ref. 1302_

Solid

DIM.

Perforated

(ext.) 600 x 400 x 300mm (int.) 530 x 340 x 272mm

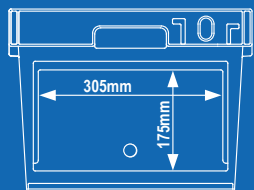

Ref. 1305	Ref. 1306
With aperture	With flap-door

Dolly (600 x 400 mm)

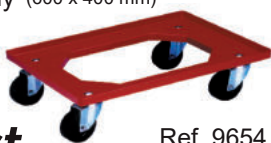

Ref. 9654_

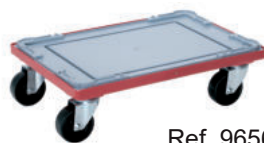

Lid (600 x 400 mm)

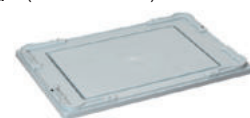

Ref. 9656_



Ref. 3006_

Versions			Perforated base and walls	Ref. 9610_	Ref. 9611_	Ref. 9612_
without corners	with low corners	with high corners				
			Solid base and walls	Ref. 9613_	Ref. 9614_	Ref. 9615_
height (mm)						
59	77	92				
			DIM. (ext.) 600 x 400 x 59mm (int.) 580 x 380 x 57mm	DIM. (ext.) 600 x 400 x 77mm (int.) 580 x 380 x 75mm	DIM. (ext.) 600 x 400 x 92mm (int.) 580 x 380 x 90mm	DIM. (ext.) 600 x 400 x 59mm (int.) 580 x 380 x 57mm
			DIM. (ext.) 600 x 400 x 77mm (int.) 580 x 380 x 75mm	DIM. (ext.) 600 x 400 x 92mm (int.) 580 x 380 x 90mm		

Stacking trays suitable for transport and storage of a wide range of products (bread, pastry, cheese, meat, hamburgers, pasta, fruit, vegetables, etc.).

Available in 12 different versions (3 stacking heights; solid or perforated walls and base).
The Ref. 9612_, 9615_, 9616_ and 9617_ are standard available from stock.

	Solid base and perforated walls	Ref. 9616_	Ref. 9617_	Ref. 9618_
On request: Marking with your company's name, address or logo.	Perforated base and solid walls	Ref. 9631_	Ref. 9632_	Ref. 9633_

Dolly (600 x 400 mm)



Ref. 9654_

Lid (600 x 400 mm)

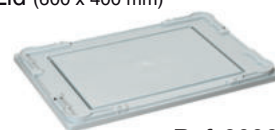

Ref. 3006_



Originally developed for the cheese and pastry industries, they are also used for other applications requiring dimensions different from 600x400mm or 400x300mm.

The lid Ref. 7860_ is suitable for Ref. 7870_ and Ref. 7871_, and it enables stable stacking of one pile of Ref. 9280_ or 2 plies of Ref. 9015_.

Ref.	DIM. (ext.)	DIM. (int.)
7870_	680x450x120mm	615x410x110mm
7871_	680x450x152mm	615x410x142mm
9015_	435x300x95mm	400x275x75mm
9280_	500x320x105mm	460x300x85mm
7860_	Lid	



Originally developed as a fish box, it is also used for many other applications which require specific dimensions different from 600x400mm.

Its design enables staggered stacking in order to optimise the use of space in the hulls of fishing boats.



Fish box

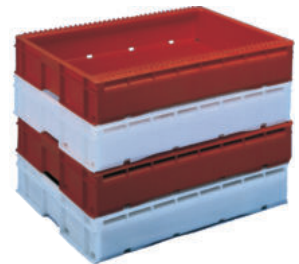

Ref. 9500_ DIM. (ext.) 725 x 485 x 130mm (int.) 680 x 475 x 118mm

Stacking box



Ref. 332_

DIM. (ext.) 500 x 310 x 255mm (int.) 470 x 280 x 245mm

Stacking box



17L

Ref. 8470_

DIM. (ext.) 400 x 300 x 170mm (int.) 370 x 270 x 165mm

Dolly (600 x 400 / 680 x 450 mm)



Ref. 9654_

Lid (680 x 450 mm)

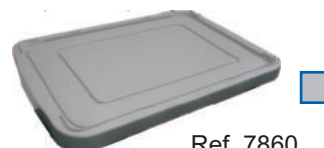

Ref. 7860_

Nesting tray



Ref. 9450_

DIM.
540mm x 380mm x 80mm

Tray used for hand luggage inspection at airports



TRAY AND BOX WITH OR WITHOUT GRIDS

The counter display tray is available with or without grids.

Tray without grids



Ref. 9450_

DIM.
540 x 380 x 80mm

Tray with 2 grids



Ref. 9451_

DIM.
540 x 380 x 80mm



Stack & nesting box with 2 grids and lid.



Ref. 9452_

Grid (295x230x13mm)

Stack & nesting box + 2 grids Ref. 9452_



Ref. 3006_

Lid (600x400mm)

Ref. 9901_

DIM.
600 x 400 x 150mm

PSAplast
.com

Plásticos Santo António, Lda.
P.O. Box 21, 2416 - 901 Leiria, Portugal
Tel. 00-351-244 81 36 00
Fax. 00-351-244 81 22 21

comercial@psaplast.com

GRAPE HARVEST

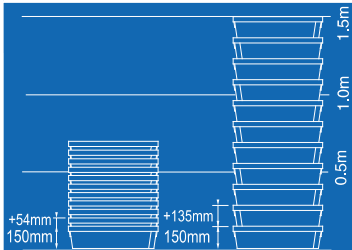
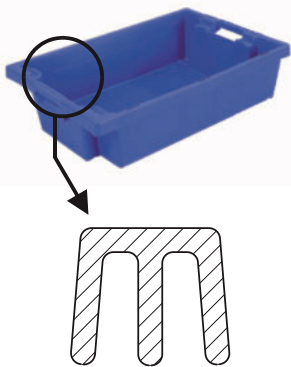

Ref. 9901_

Solid

DIM.
600 x 400 x 150mm 195/ 

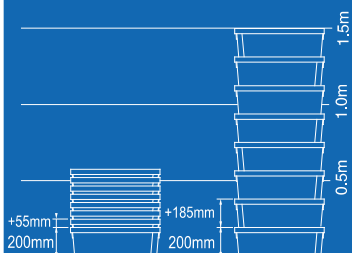
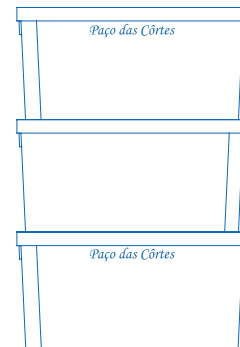

Ref. 9701_

Solid

DIM.
600 x 400 x 200mm 190/ 

Printing on one side enables the user to distinguish between the stacking and the nesting positions:
- when stacked, the prints alternate.
- when nested, all the prints are on the same side.

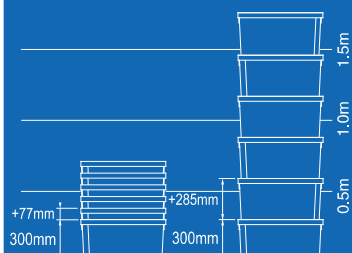

Ref. 9751_

Solid

DIM.
600 x 400 x 300mm 130/ 

The weights of grapes are a rough indication.

Dolly (600 x 400 mm)



Ref. 9654_

Lid (600 x 400 mm)

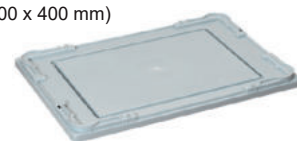

Ref. 3006_

PSAplast
.com

Plásticos Santo António, Lda.
P.O. Box 21, 2416 - 901 Leiria, Portugal

Tel. 00-351-244 81 36 00
Fax. 00-351-244 81 22 21

comercial@psaplast.com

PALLET-BOXES

Ref. P749L_

Lid 1,2x1m



Solid

DIM ext. (mm)
1200 x 1000 x 1200



Perforated

DIM int. (mm)
1127 x 927 x 1044 1120 Ltrs

Ref.	Skids
P742T0N_	2
P742E0N_	2-R
P742U0N_	3
P742F0N_	3-R

Ref.	Skids
P741T0N_	2
P741E0N_	2-R
P741U0N_	3
P741F0N_	3-R

R = Removable Skids
(The strongest version)



Solid

DIM ext. (mm)
1200 x 1000 x 900



Perforated

DIM int. (mm)
1121 x 921 x 744 800 Ltrs

Ref.	Skids
P744T0N_	2
P744E0N_	2-R
P744U0N_	3
P744F0N_	3-R

Ref.	Skids
P743T0N_	2
P743E0N_	2-R
P743U0N_	3
P743F0N_	3-R

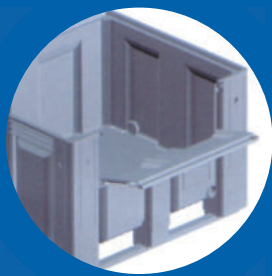

Ref. P746T0D_

Solid, with 2 skids and drop door



Solid

DIM ext. (mm)
1200 x 1000 x 760



Perforated

DIM int. (mm)
1119 x 919 x 604 650 Ltrs

Ref.	Skids
P746T0N_	2
P746E0N_	2-R
P746U0N_	3
P746F0N_	3-R

Ref.	Skids
P745T0N_	2
P745E0N_	2-R
P745U0N_	3
P745F0N_	3-R

PSAplast
.com

Plásticos Santo António, Lda.
P.O. Box 21, 2416 - 901 Leiria, Portugal

Tel. 00-351-244 81 36 00
Fax. 00-351-244 81 22 21

comercial@psaplast.com

PALLETS & FLOOR SLATS

Suitable for food contact.
Not suitable for racking.
With 9 feet (no skids).
Nest to save space.



LOAD	
STATIC	DYNAMIC
1000 Kg	800 Kg



Ref. 2281_

Pallet



6,9 Kg

DIM.
1200 x 800 x 150mm

Suitable for food contact.
With 2 skids.

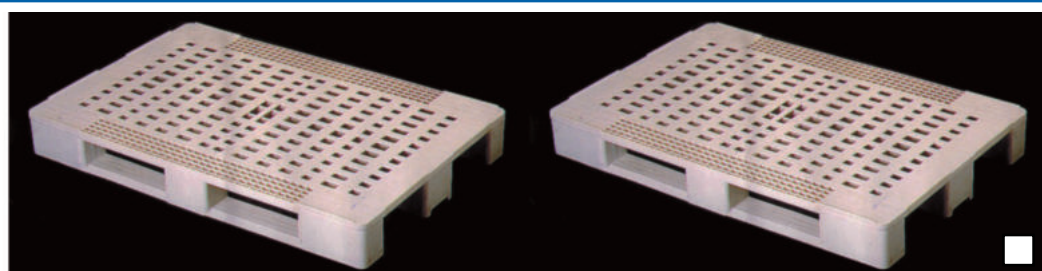

LOAD		
STATIC	DYNAMIC	RACKING
1500 Kg	1000 Kg	400 Kg

Ref. 9662_

Pallet



14,4 Kg

DIM.
1200 x 800 x 145mm

Suitable for food contact.

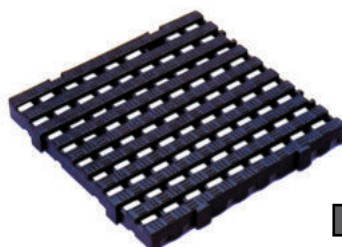

Ref. 9660_

Floor Slat

DIM.
500 x 500 x 48mm

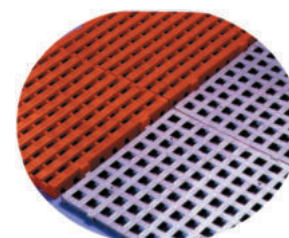

Ref. 9661_

DIM.
500 x 500 x 24mm

PSAplast
.com

Plásticos Santo António, Lda.
P.O. Box 21, 2416 - 901 Leiria, Portugal

Tel. 00-351-244 81 36 00
Fax. 00-351-244 81 22 21

comercial@psaplast.com

Volume

80L WASTE BINS



Ref. 7900_

Waste bin without lid



Ref. 7901_

Waste bin with lid

DIM.
Ø 480 mm x 670 mm
80 L



Ref. 7902_

Lid

PSAplast
.com

Plásticos Santo António, Lda.
P.O. Box 21, 2416 - 901 Leiria, Portugal

Tel. 00-351-244 81 36 00 4 81 36 00
Fax. 00-351-244 81 22 21 4 81 33 21

comercial@psaplast.com

WASTE SEPARATION BINS

Container with flat lid



Ref. 9570_

60 L

DIM.

585 x 435 x 360mm

Bin with pedal



Ref. 9580_

60 L

DIM.

730 x 430 x 400mm

Bin with push-down lid



Ref. 9590_

60 L

DIM.

680 x 430 x 345mm

Bin without lid



8 L

295 x 195 x 195mm

Ref. 8900_



6,2 L

217 x 160 x 290mm

Ref. 0230_



13,5 L

217 x 255 x 290mm

Ref. 0240_

Container without lid



Ref. 7880_

60L

DIM.

560 x 425 x 340mm

Flip top bins



Ref. 9224_

40L

DIM.

690 x 420(Ø380)mm



Ref. 8901_

8L

DIM.

390 x 200 x 200mm

PSAplast
.com

Plásticos Santo António, Lda.
P.O. Box 21, 2416 - 901 Leiria, Portugal
Tel. 00-351-244 81 36 00
Fax. 00-351-244 81 22 21

comercial@psaplast.com

Tamper evident bucket

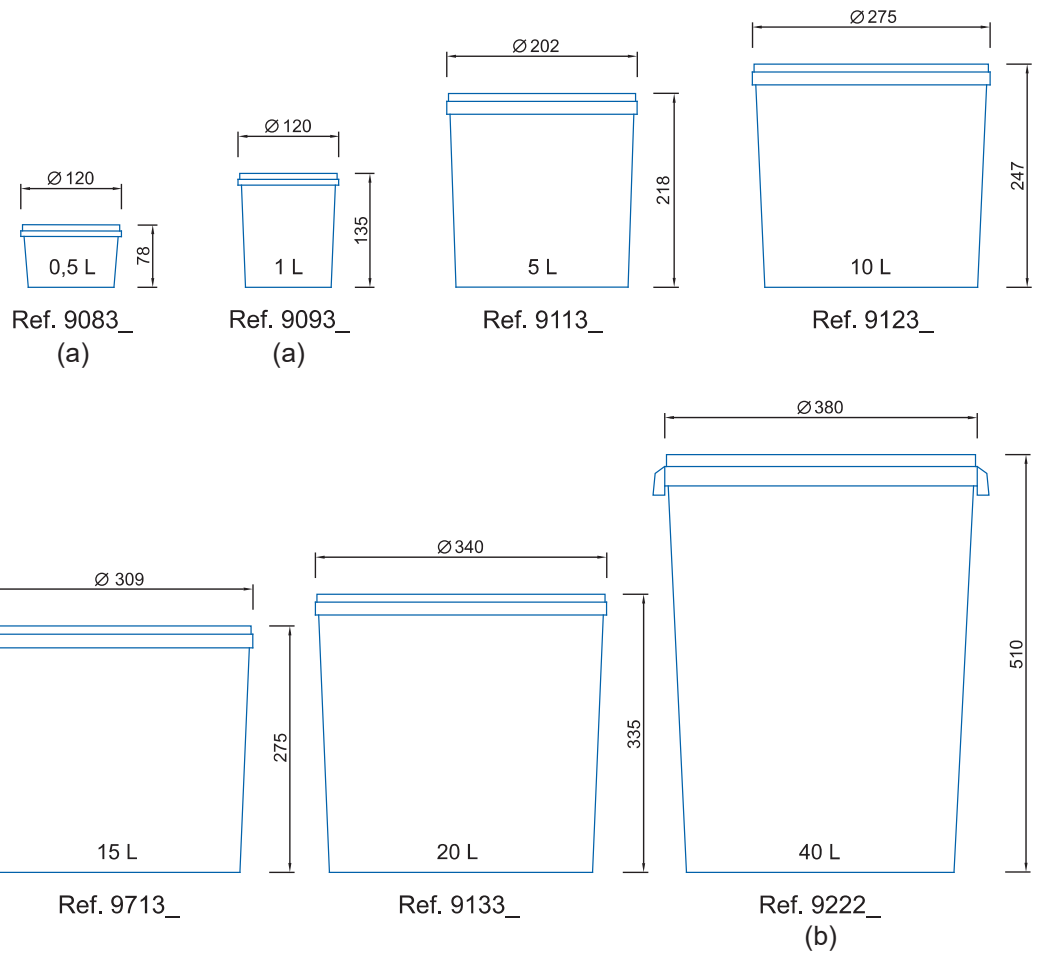

a) without handle
b) with 2 handles

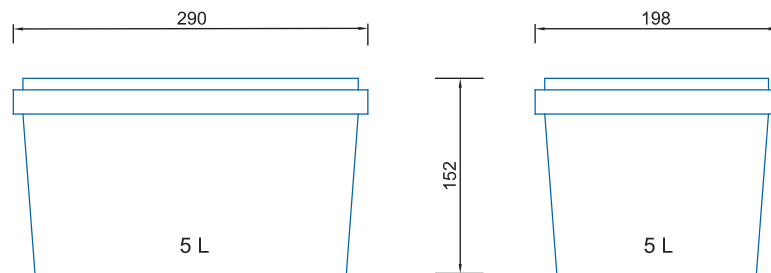

Ref. 9561_

Oblong bucket

TAMPER EVIDENT CONTAINERS WITH SNAP-ON CLOSURE

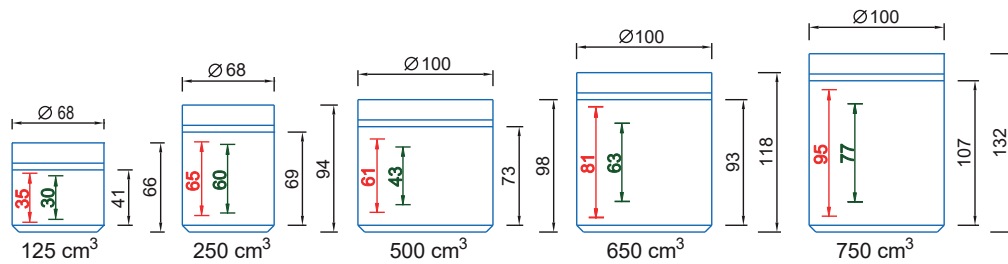

Ref. 9470_

Ref. 9390_

Ref. 9370_

Ref. 9371_

Ref. 9372_

The lids feature a tamper evident ring.

The containers are produced in white HDPE, and the lids in LDPE.

Comply with the European food contact regulations.

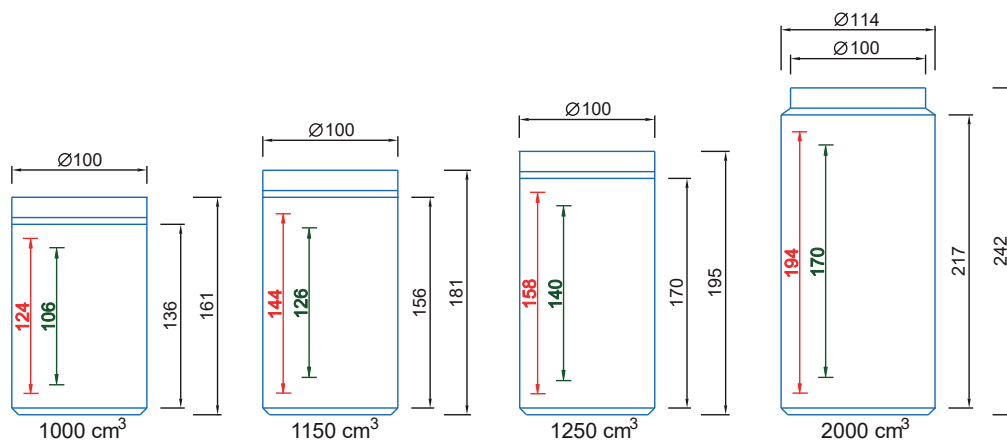

Ref. 9380_

Ref. 9381_

Ref. 9382_

Ref. 9271_

Label maximum height (mm)
 Screen printing maximum height (mm)

PSAplast
.com

Plásticos Santo António, Lda.
P.O. Box 21, 2416 - 901 Leiria, Portugal

Tel. 00-351-244 81 36 00
Fax. 00-351-244 81 22 21

comercial@psaplast.com